

# ***STANDARD HORIZON***

*Nothing takes to water like Standard Horizon*

## **HX300E**

Floating VHF FM Marine Transceiver

---

## **Owner's Manual**













# TABLE OF CONTENTS

Quick Reference Guide.....	3
<b>1. GENERAL INFORMATION.....</b>	<b>4</b>
1.1 INTRODUCTION.....	4
1.2 RF EXPOSURE SAFETY STATEMENT.....	4
<b>2. ACCESSORIES.....</b>	<b>5</b>
2.1 PACKING LIST.....	5
2.2 OPTIONS.....	5
<b>3. ABOUT THIS RADIO.....</b>	<b>6</b>
3.1 ABOUT THE VHF MARINE BAND.....	6
3.2 ABOUT WATER RESISTANCE.....	6
3.3 DISTRESS AND HAILING (CHANNEL 16).....	6
3.4 CALLING ANOTHER VESSEL (CHANNEL 16 OR 9).....	7
3.5 OPERATING ON CHANNEL 13 AND 67 (USA Channel Group Only).....	8
3.6 SIMPLEX / DUPLEX CHANNEL USE.....	8
<b>4. GETTING STARTED.....</b>	<b>10</b>
4.1 RADIO CARE.....	10
4.2 BATTERIES AND CHARGERS.....	10
4.2.1 BATTERY SAFETY.....	11
4.2.2 BATTERY INSTALLATION / REMOVAL.....	12
4.2.3 BATTERY CHARGING.....	13
4.3 BELT CLIP INSTALLATION / REMOVAL.....	14
HAND STRAP INSTALLATION.....	14
4.4 INSTALLATION OF OPTION.....	15
4.4.1 FBA-44 ALKALINE BATTERY CASE.....	15
<b>5. CONTROLS AND INDICATORS.....</b>	<b>16</b>
5.1 CONTROLS AND SWITCHES.....	16
5.2 LCD INDICATORS.....	19
<b>6. BASIC OPERATION.....</b>	<b>21</b>
6.1 INITIAL SETUP.....	21
6.2 RECEPTION.....	21
6.3 TRANSMISSION.....	22
6.3.1 TRANSMIT TIME-OUT TIMER (TOT).....	22
WATER ENABLED LIGHT.....	22
6.4 USA, CANADIAN, AND INTERNATIONAL CHANNELS.....	23
6.5 KEYPAD LOCKING.....	23
6.6 PRESET CHANNELS (0 ~ 9): INSTANT ACCESS.....	23
6.6.1 PROGRAMMING.....	23
6.6.2 OPERATION.....	24
6.6.3 DELETING A PRESET CHANNEL.....	24
6.7 SCANNING.....	24
6.7.1 PROGRAMMING SCAN MEMORY.....	24
6.7.2 SELECTING SCAN TYPE.....	25
6.7.3 OPERATION.....	26
6.7.3.1 Priority Scan.....	26
6.7.3.2 Memory Scan.....	26
6.8 DUAL WATCH.....	27
6.9 TRI-WATCH.....	28
<b>7. ATIS SETUP.....</b>	<b>29</b>
7.1 ATIS CODE PROGRAMMING.....	29
7.2 ATIS CH GROUP.....	30
<b>8. MENU ("SET") MODE.....</b>	<b>31</b>
<b>9. MAINTENANCE.....</b>	<b>33</b>
9.1 GENERAL.....	33
9.2 REPLACEMENT PARTS.....	33
9.3 TROUBLESHOOTING CHART.....	33
<b>10. VHF MARINE CHANNEL ASSIGNMENT.....</b>	<b>34</b>
<b>11. SPECIFICATIONS.....</b>	<b>38</b>
11.1 GENERAL.....	38
11.2 TRANSMITTER.....	38
11.3 RECEIVER.....	38

# QUICK REFERENCE GUIDE

This transceiver is equipped with the E2O (Easy-To-Operate) system. You can do the basic operation in numerical order of the illustration below.

- ① Press and hold the  key to turn on or off the radio.
- ② Press the  key ("VOL" indicator blinks), then press the  key to adjust the speaker audio volume.
- ③ Press the  key to select the operating channel.
- ④ Press the  key two times ("SQL" indicator blinks), then press the  key to squelch or press the  key to un-squelch the radio.
- ⑤ Press the  key to toggle the transmit power between High (5W) and Low (1W).
- ⑥ Press the  key briefly to recall channel 16.  
Press and hold the  key for two seconds to recall channel 9.  
Press the  key again to revert to the last selected channel.
- ⑦ Place your mouth about 2.5 cm away from MIC hole and speak in a normal voice level while pressing the **PTT** switch.



# 1. GENERAL INFORMATION

## 1.1 INTRODUCTION

The **HX300E** is a Submersible Floating 5-Watt portable two way marine transceiver. The transceiver has all allocated USA, International, or Canadian channels. It has emergency channel 16 which can be immediately selected from any channel by pressing the  key.

The **HX300E** includes the following features: Memory Scanning, Priority Scanning, Dual and Tri-watch, easy-to-read large LCD display, Battery Life displayed on LCD, the Water Enabled Light which blinks automatically when the radio comes in contact with water even if the radio is turned off, and a transmit Time-Out Timer (TOT).

The **HX300E** transmitter provides a full 5 Watt of transmit power and also is selectable to 1 Watt to assist the user in ensuring maximum battery life.

The **HX300E** supports ATIS mode which is used in the inland waterways of Europe. Please contact your local PTT administration or Marine Authority to obtain your ATIS number.

We appreciate your purchase of the **HX300E**, and encourage you to read this manual thoroughly, so as to learn and fully understand the capabilities of the **HX300E**.

## 1.2 RF EXPOSURE SAFETY STATEMENT

Your wireless handheld portable transceiver contains a low power transmitter. When the Push-to-Talk (PTT) button is pushed, the transceiver sends out radio frequency (RF) signals.

This device is authorized to operate at a maximum duty factor not to exceed 2:1 (this corresponds to 50% transmission time and 50% reception time), but normal usage should not exceed 3:1 (25% transmission time and 75% reception/standby time).

This transmitter and its antenna must maintain a separation distance of at least 2.5 cm from your face. Speak in a normal voice, with the antenna pointed up and away from the face at the required separation distance.

Use only the supplied antenna. Unauthorized antennas, modifications, or attachments could damage the transmitter.

## 2. ACCESSORIES

### 2.1 PACKING LIST

When the package containing the transceiver is first opened, please check it for the following contents:

- **HX300E** Transceiver
- **CAT460** Antenna
- **FNB-122LI** 3.7 V, 1560 mAh Li-ion Battery Pack
- **PA-54C/U\*** USB Wall Charger (100 - 240 VAC) and Cable
- **CLIP-22** Belt Clip
- Hand Strap
- Owner's Manual
- Warranty Card

### 2.2 OPTIONS

- ① **CN-3** Radio-to-Ship's-Antenna Adapter
- ② **FNB-122LI** 3.7 V, 1560 mAh Li-ion Battery Pack
- ③ **FBA-44** Alkaline Battery Case (3 x "AAA" Cell Size)
- ④ **PA-54B/C/U\*** USB Wall Charger and Cable

※: "B" suffix has a Type-A plug, "C" suffix has a Type-C plug, and "U" suffix has a Type-BF plug. All versions of the USB Wall Charger are available in 100-240 VAC.

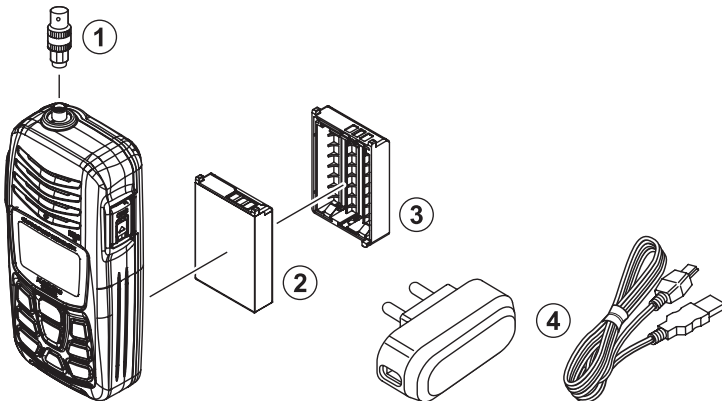

**Note:** Before operating the **HX300E** for the first time, it is recommended that the battery be charged. Please see section "**4.2.3 BATTERY CHARGING**" for details.

## 3. ABOUT THIS RADIO

### 3.1 ABOUT THE VHF MARINE BAND

The radio frequencies used in the VHF marine band lie between 156 and 158 MHz. The marine VHF band provides communications over distances that are essentially “Line of sight” Actual transmission range depends much more on antenna type, gain and height than on the power output of the transmitter. On a fixed mount 25 W radio transmission expected distances can be greater than 25 km, for a portable radio transmission the expected distance can be greater than 8 km in “Line of sight”.

The user of a Marine VHF radio is subject to severe fines if the radio is used on land. The reasoning for this is you may be near an inland waterway, or propagation anomalies may cause your transmission to be heard in a waterway. If this occurs, depending upon the marine VHF channel on which you are transmitting, you could interfere with a search and rescue case, or contribute to a collision between passing ships. For VHF Marine channel assignments refer to section “**10. VHF MARINE CHANNEL ASSIGNMENT**”.

### 3.2 ABOUT WATER RESISTANCE

The **HX300E** is only submersible\* when the Battery Cover is latched and the Charge (CHG) Cover is snapped closed.

※ IPX8 Specification for submersibility: 1.5 m for 30 minutes.

### 3.3 DISTRESS AND HAILING (CHANNEL 16)

Channel 16 is known as the Hail and Distress Channel. An emergency may be defined as a threat to life or property. In such instances, be sure the transceiver is on and set to “Channel 16”. Then use the following procedure:

1. Press the **PTT** (Push-To-Talk) switch and say “**Mayday, Mayday, Mayday**. This is \_\_\_\_\_, \_\_\_\_\_, \_\_\_\_\_” (your vessel’s name).
2. Then repeat once: “**Mayday, \_\_\_\_\_**” (your vessel’s name).
3. Now report your position in latitude/longitude, or by giving a true or magnetic bearing (state which) to a well-known landmark such as a navigation aid or geographic feature such as an island or harbor entry.
4. Explain the nature of your distress (sinking, collision, aground, fire, heart attack, life-threatening injury, etc.).
5. State the kind of assistance your desire (pumps, medical aid, etc.).
6. Report the number of persons aboard and condition of any injured.
7. Estimate the present seaworthiness and condition of your vessel.
8. Give your vessel’s description: length, design (power or sail), color and other distinguishing marks. The total transmission should not exceed 1

minute.

9. End the message by saying “**OVER**”. Release the **PTT** switch and listen.
10. If there is no answer, repeat the above procedure. If there is still no response, try another channel.

### **3.4 CALLING ANOTHER VESSEL (CHANNEL 16 OR 9)**

Channel 16 may be used for initial contact (hailing) with another vessel.

However, its most important use is for emergency messages. This channel must be monitored at all times except when actually using another channel.

It is monitored by the U.S. and Canadian Coast Guards and by other vessels. Use of channel 16 for hailing must be limited to initial contact only. Calling should not exceed 30 seconds, but may be repeated 3 times at 2-minute intervals. In areas of heavy radio traffic, congestion on channel 16 resulting from its use as a hailing channel can be reduced significantly in U.S. waters by using Channel 9 as the initial contact (hailing) channel for non-emergency communications. Here, also, calling time should not exceed 30 seconds but may be repeated 3 times at 2-minute intervals.

Prior to making contact with another vessel, refer to the channel charts in this manual, and select an appropriate channel for communications after initial contact. For example, Channels 68 and 69 of the U.S. VHF Charts are some of the channels available to non-commercial (recreational) boaters. Monitor your desired channel in advance to make sure you will not be interrupting other traffic, and then go back to either channel 16 or 9 for your initial contact.

When the hailing channel (16 or 9) is clear, state the name of the other vessel you wish to call and then “**this is**” followed by the name of your vessel and your Station License (Call Sign). When the other vessel returns your call, immediately request another channel by saying “**go to**”, the number of the other channel, and “**over**”. Then switch to the new channel. When the new channel is not busy, call the other vessel.

After a transmission, say “**over**”, and release the **PTT** (Push-To-Talk) switch. When all communication with the other vessel is completed, end the last transmission by stating your Call Sign and the word “**out**”. Note that it is not necessary to state your Call Sign with each transmission, only at the beginning and end of the contact.

Remember to return to Channel 16 when not using another channel. Some radios automatically monitor Channel 16 even when set to other channels or when scanning.

### **3.5 OPERATING ON CHANNELS 13 AND 67**

#### **(USA Channel Group Only)**

Channel 13 is used at docks and bridges and by vessels maneuvering in port. Messages on this channel must concern navigation only, such as meeting and passing in restricted waters.

Channel 67 is used for navigational traffic between vessels.

By regulation, power is normally limited to 1 Watt on these channels. Your radio is programmed to automatically reduce power to this limit on these channels. However, in certain situations it may be necessary to temporarily use a higher power.

Pressing the  key will change the power output from Low Power (1 Watt) to High (5 Watts). When you change from this channel then return to it, low power will be automatically selected.

### **3.6 SIMPLEX/DUPLEX CHANNEL USE**

Refer to the section “**10. VHF MARINE CHANNEL ASSIGNMENT**” for instructions on use of simplex and duplex channels.

#### **NOTE**

All channels are factory-programmed in accordance with FCC (USA), Industry Canada and International regulations. The mode of operation cannot be altered from simplex to duplex or vice-versa. Simplex (ship to ship) or duplex (marine operator) mode is automatically activated, depending on the channel and whether the USA, International or Canadian operating band is selected.



# MEMO

A series of horizontal dashed lines for writing a memo.

## 4. GETTING STARTED

### 4.1 RADIO CARE

#### CAUTION

Before following the instructions below, insure the battery pack is in place and the cover is latched. Care must be taken if the radio was dropped and a close inspection may be needed to insure the radio case and gaskets are in adequate condition.

After using the **HX300E** in salt water environment is recommended to clean the radio with fresh by rinsing the radio under a sink faucet or by dunking the radio in a bucket of fresh water. After washing, use a soft cloth and thoroughly dry all parts of the radio. This is to keep the rubber switches and speaker grill clean and in top operating condition.

### 4.2 BATTERIES AND CHARGERS

If the radio has never been used, or its charge is depleted, it may be charged by connecting the **PA-54C/U** USB Wall Charger with the Charge Cable, see section “**4.2.3 BATTERY CHARGING**”. The **PA-54C/U** will charge a completely discharged **FNB-122LI** battery pack in about 6 hours.

If the USB port is available (such as your personal computer), You may charge the **FNB-122LI** battery pack by connecting the supplied Charge Cable between the **HX300E** and USB port.

The **FNB-122LI** is a high performance Li-ion battery providing high capacity in a compact package.

#### FNB-122LI Rechargeable Battery Pack

<b>Capacity</b>	1560 mAh			
<b>Nominal Voltage</b>	3.7 V			
<b>Temperature Range</b>	<b>Minimum</b>		<b>Maximum</b>	
	<b>°C</b>	<b>°F</b>	<b>°C</b>	<b>°F</b>
<b>Charge</b>	5	41	35	95
<b>Discharge</b>	-20	-4	60	140
<b>Storage</b>	-10	14	35	95

#### CAUTION

To avoid risk of explosion and injury, **FNB-122LI** battery pack should only be removed, charged or recharged in non-hazardous environments.

### **4.2.1 BATTERY SAFETY**

Battery packs for your transceiver contain Li-ion batteries. This type of battery stores a charge powerful enough to be dangerous if misused or abused, especially when removed from the transceiver. Please observe the following precautions:

**DO NOT SHORT BATTERY PACK TERMINALS:** Shorting the terminals that power the transceiver can cause sparks, severe overheating, burns, and battery cell damage. If the short is of sufficient duration, it is possible to melt battery components. Do not place a loose battery pack on or near metal surfaces or objects such as paper clips, keys, tools, etc. When the battery pack is installed on the transceiver, the terminals that transfer current to the transceiver are not exposed. The terminals that are exposed on the battery pack when it is mounted on the transceiver are charging terminals only and do not constitute a hazard.

**DO NOT INCINERATE:** Do not dispose of any battery in a fire or incinerator. The heat of fire may cause battery cells to explode and/or release dangerous gases.

#### **Battery Maintenance**

For safe and proper battery use, please observe the following:

- Battery packs should be charged only in non-hazardous environments;
- Use only STANDARD HORIZON-approved batteries;
- Exceeding the specified temperature limits;
- Reversing charge polarity. Use only the proper charger. If this is tampered with or another charger is used, permanent damage may result;
- Use only a STANDARD HORIZON approved charger. The use of any other charger may cause permanent damage to the battery.
- Follow charging instructions provided with the chargers.
- Submersing the battery in water, or attempting to open the battery casing.
- Keep the battery contacts clean.

#### **Battery Storage**

When a battery pack is not used for a long time, please remove it from the transceiver. Also, while in storage, the charge will drain slightly over time and the battery should be recharged each six months.

Store the batteries in a cool place to maximize storage life. Since batteries are subject to self-discharge, avoid high storage temperatures that cause large self-discharge rates. After extended storage, a full recharge is recommended.

## Battery Recycling

**DO NOT PLACE USED BATTERIES IN YOUR REGULAR TRASH!  
LI-ION BATTERIES MUST BE COLLECTED, RECYCLED  
OR DISPOSED OF IN AN ENVIRONMENTALLY SOUND  
MANNER.**



The incineration, land filling or mixing of Li-ion batteries with the municipal solid waste stream is PROHIBITED BY LAW in most areas.

Return batteries to an approved Li-ion battery recycler. This may be where you purchased the battery.

Contact your local waste management officials for other information regarding the environmentally sound collection, recycling and disposal of Li-ion batteries.

### **4.2.2 BATTERY INSTALLATION / REMOVAL**

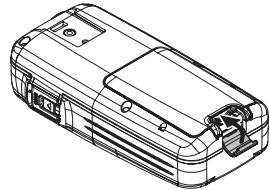
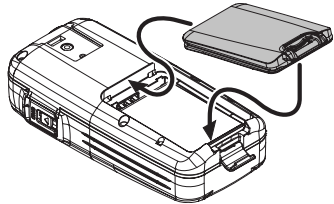
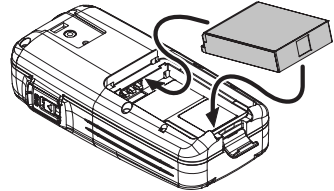

- Open the Battery Cover Latch on the bottom of the radio, then remove the Battery Cover from the radio while pulling the bottom side of the Battery Cover.
- Install the **FNB-122LI** Battery Pack into the radio, by carefully mating the battery's two alignment tabs on the top side of the Battery Pack with their corresponding alignment slots in the Battery Nest of the radio, then gently press the bottom side of the Battery Pack until it locks in place.
- Install the Battery Cover by carefully aligning the two tabs on the top of the cover with the slots on the radio, then gently press the bottom side of the Battery Cover. Confirm that a Rubber Gasket of the Battery Cover is installed correctly.
- Close the Battery Cover Latch until it locks in place with a "Click".



#### **CAUTION**

To insure the **HX300E** will not have a problem with water intrusion, make sure the battery cover is properly installed and the battery latch is closed.

### **4.2.3 BATTERY CHARGING**

1. Turn the transceiver off.
2. Slide the **CHG** cover button (with arrow) up to open the **CHG** cover, then connect the supplied Charge Cable to the **CHG** jack on the **HX300E**.
3. Connect the other side plug of the supplied Charge Cable to the **PA-54C/U**, then plug the **PA-54C/U** into the AC line outlet.
4. If the connection is correct, the “” and “**CHG**” icon will appear in the display. A fully-discharged pack will be charged completely in approximately 6 hours.
5. When charging is completed, the “” icon disappears and “**FL**” will appear in the display. Disconnect the Charge Cable from the **HX300E** and close the **CHG** cover securely (make sure a click is heard), then unplug the **PA-54C/U** from the AC line outlet.

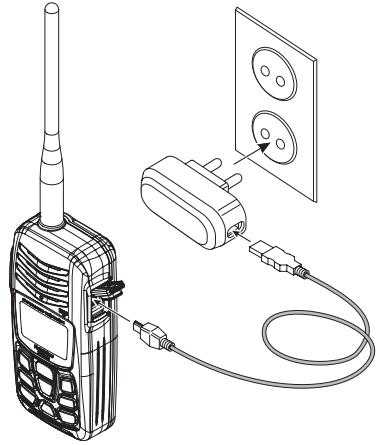

#### **CAUTION**

- When using the radio, make sure the **CHG** cover is completely closed to insure water integrity.
- The **PA-54C/U** is NOT designed to be waterproof. Do not attempt to charge in water hazardous locations.

#### **NOTE**

- The **HX300E** may also be charged by connecting the USB cable to the radio and a USB connector on a PC. It will take about 6 hours to charge the battery and FL will be shown on the **HX300E** display when charging is completed.
- The **PA-54C/U** is only designed for the charging of the **HX300E**'s battery pack, and is not suitable for other purposes. The **PA-54C/U** may contribute noise to TV and radio reception in the immediate vicinity, so it do not recommend its use adjacent to such device.
- When carefully maintained, a pack should be useful for about 300 charge/discharge cycles.

### 4.3 BELT CLIP INSTALLATION / REMOVAL

- To install the Belt Clip: align the Belt Clip to the groove of the Battery pack, then press the Belt Clip downward until it locks in place with a “Click”.
- To remove the Belt Clip: press the Belt Clip Tab away from the battery pack to unlock the Belt Clip, then slide the Belt Clip upward to remove it.

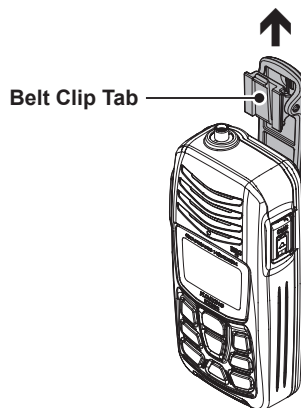
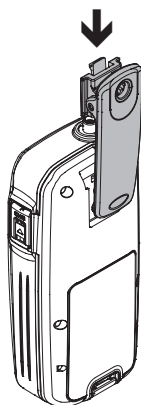

#### HAND STRAP INSTALLATION

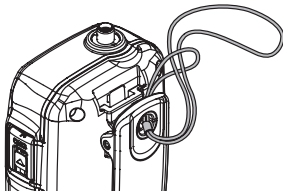

## 4.4 INSTALLATION OF OPTION

### 4.4.1 FBA-44 ALKALINE BATTERY CASE

**FBA-44** is a Battery Case that holds three “AAA” size Alkaline Batteries and is used with the **HX300E** transceiver.

#### CAUTION

To insure the **HX300E** will not have a problem with water intrusion, make sure the battery cover is properly installed and the battery latch is closed.

#### IMPORTANT NOTE

The power output will be reduced to “Low Power” (1 W) automatically when using the **FBA-44**.

- ❑ Install the three “AAA” size Alkaline Batteries into the **FBA-44** Battery Case with the Negative (–) side of the batteries touching the spring connections inside the **FBA-44** Battery Case (Figure 1).
- ❑ Turn over the **FBA-44** Battery Case, then insert the **FBA-44** Battery Case into the Battery Compartment, by a same manner of the installation of the **FNB-122LI** (Figure 2).
- ❑ Re-install the Battery Cover (Figure 3), then close the Battery Cover Latch until it locks in place with a “Click” (Figure 4).

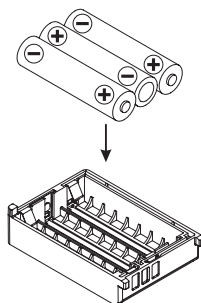

FIGURE 1

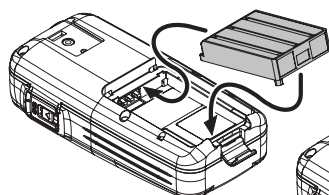

FIGURE 2

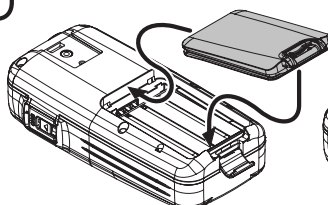

FIGURE 3

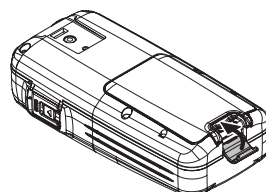

FIGURE 4

#### NOTE

- The **FBA-44** is designed for use only with “AAA” size Alkaline Cells. Do not attempt to install any rechargeable battery cell.
- If you do not use the **HX300E** for a long time, remove the Alkaline batteries from the **FBA-44**, as battery leakage could cause damage to the **FBA-44** and/or **HX300E**.

## 5. CONTROLS AND INDICATORS

### 5.1 CONTROLS AND SWITCHES

#### NOTE

This section defines each control of the transceiver. For detailed operating instructions, refer to section “6. BASIC OPERATION”. Refer to illustrations for the location of the following controls, switches, and connections.



- ① **ANT Jack (Top Panel)**  
The supplied **CAT460** flexible antenna is attached here.
- ② **PTT (PUSH-TO-TALK) Switch (Left Side Panel)**  
When pushed activates the transmitter.
- ③ **LCD Display**  
This display shows current operating conditions, as indicated on the page 19.



#### ④ Keypad



##### Key

Pressing this key immediately recalls channel 16 from any channel location. Holding down this key recalls channel 9. Pressing this key again reverts to the previous selected working channel.

##### Key

Press to stop the Scan, Priority Scan, Dual or Tri-Watch feature.





##### **Secondary use:**

When the  key is held and the  key is pressed, the radio will change the marine band between the USA, International, and Canadian channels.

##### Key

Press this key to toggle the transmitter output power between “High” (5 Watts) and “Low” (1 Watt) power. This key does not function on the “Transmission Inhibited” and “Low power only” channels.

##### **Secondary use:**

Hold down this key to lock the keypad (except the ,  and **PTT** keys) so that they are not accidentally changed. The “” Keylock icon will appear at the top left on the display, to indicate that the functions are locked. Hold down this key until the “” Keylock icon disappears to unlock the radio.

##### Key

Press this key to change the operating channel, receiver volume level, and squelch threshold level.

Press the key momentarily, the channel (or level) will increase one step. Holding the key, the channel (or level) will increase continuously.

##### Key

Press this key to change the operating channel, receiver volume level, and squelch threshold level.

Press the key momentarily, the channel (or level) will decrease one step. Holding the key, the channel (or level) will decrease continuously.

##### Key

Press and hold this key for two seconds to turn the radio “on” or “off”.



Press this key to toggle the operation mode from Speaker Volume adjustment, SQL adjustment, and Channel selection.

**Secondary use:**

- a. Press and hold this key to open the squelch, allowing you to monitor the operating channel. Release the key to resume normal (quiet) monitoring.
- b. Setup mode may be enabled. Refer section **“8. MENU (“SET”) MODE”** for details



Starts scanning and priority scanning of channels programmed into memory. Refer to section **“6.7.1 PROGRAMMING SCAN MEMORY”**.

**Secondary use:**

- a. Press and hold the key for two seconds to activate the Dual Watch feature.
- b. Used to program channels into Scan memory. Refer to section **“6.7.1 PROGRAMMING SCAN MEMORY”**.



Immediately recalls one of up to 10 user preset memories for each band (shown as “P0” - “P9” on the LCD). Refer to section **“6.6.2 OPERATION”**.





**Secondary use:**

Used to program channels into the Preset Channel memory. Refer to section **“6.6.1 PROGRAMMING”**.

- ⑤ Speaker  
The internal speaker is located here.
- ⑥ CHG (Charge) Cover/Jack (Left Side Panel)  
This mini-USB (Type-B) jack allows to connection to the supplied **PA-54C/U** USB Wall Charger with the supplied Charge Cable.
- ⑦ Microphone  
The internal microphone is located here.  
When transmitting, position your mouth about 1.2 to 2.5 cm away from the small mic hole. Speak slowly and clearly into the microphone.
- ⑧ Water Enabled Light  
When the **HX300E** comes in contact with water, the light will blink red to assist finding the radio in low light conditions. This feature operates when the radio is on or off. To setup the blinking of the light refer to section **“8. MENU (“SET”) MODE”**.

- ⑨ **Water Enabled Light Terminals**  
These terminals are used to detect water to enable the Water Enabled Light.  
When these terminals touch water, the Water Enabled Light blinks. Keep these terminals clean.
- ⑩ **Battery Cover Latch (Bottom side)**  
Open the battery cover lock latch allows access to remove the Lithium-Ion battery or optional Alkaline battery tray.

## 5.2 LCD INDICATORS





- ① **“” Keylock Indicator**  
When the “” Keylock icon is shown on the LCD, all keys are disabled except for the PTT, , and  keys.

- ② **“” Indicator**  
This indicator appears during transmission.

- ③ **“” Indicator**  
This indicator appears when a signal is being received or the radio is un-squelched.

- ④ **“” Indicator**  
These indicators show the “band” of operation. “**U**” indicates the USA band; “**I**” indicates the International band; and “**C**” indicates the Canadian band.

- ⑤ **“” Indicator**  
This indicator appears when the Scan is activated.

- ⑥ **“” Battery Indicator**  
  - “” : Full battery
  - “” : Lower battery
  - “” : Battery is very low
  - “ (Blinking)” : Prepare to charge the battery

- ⑦ **“” Indicator**  
Shown when the channel is programmed into the Preset Channel memory.

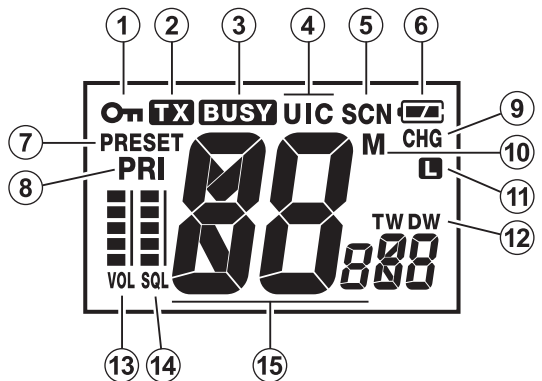

- ⑧ **“PRI”** Indicator  
This indicator shows the channel is in the “Priority Channel”.
- ⑨ **“CHG”** (Charge) Indicator  
This indicator appears during battery charging.
- ⑩ **“M”** Indicator  
This indicator shows the channel is in the transceiver’s “Scan Memory”.
- ⑪ **“L”** Indicators  
This indicator shows the TX output power is “Low” (1 Watt) power.

**NOTE**

When the <b>“L”</b> icon is not shown the power is set to 5 Watts.
--













- ⑫ **“TW DW”** Indicator  
“**TW**”: Tri-Watch is activated.  
“**DW**”: Dual Watch is activated.
- ⑬ **VOL** Indicator  
This indicator shows the receive audio volume level.
- ⑭ **SQL** Indicator  
This indicator shows the squelch level.
- ⑮ Channel Display  
The operating channel is shown on the LCD in both the transmission and reception modes.

## 6. BASIC OPERATION

### 6.1 INITIAL SETUP

1. Install the battery pack on the transceiver (see section “4.2.2 BATTERY INSTALLATION/REMOVAL”).
2. Install the antenna onto the transceiver; hold the bottom end of the antenna, then screw it onto the mating connector on the transceiver until it is snug. Do not over-tighten.

### 6.2 RECEPTION

1. Press and hold the  key for two seconds to turn the radio “on”.
2. Press the  key twice (“SQL” will be blinking).
3. While “SQL” is blinking, press the  key until the “**BUSY**” indicator will appear on the display, then press the  key.
4. Press the  key (“VOL” will be blinking).
5. While “VOL” is blinking, press the  key until the noise or audio from the speaker is at a comfortable level, then press the  key.
6. Activate the squelch adjusting mode by pressing the  key twice (the “SQL” indicator blinks). Press the  key until the random noise disappears, then press the  key. This state is known as the “Squelch Threshold”.
7. Press the  key to select the desired channel. Refer to section “10. VHF MARINE CHANNEL ASSIGNMENTS” for available channels.
8. When a signal is received, adjust the volume (press the  key, followed by the  key) to the desired listening level. The “**BUSY**” indicator in the LCD is displayed indicating that the channel is being used or the radio is not squelched.

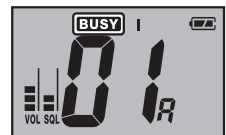
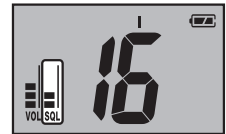
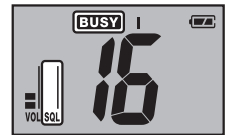

## 6.3 TRANSMISSION

1. Perform “**6.2 RECEPTION**” discussion above.
2. Before transmitting, monitor the channel and make sure it is clear.

3. For communications over short distances, press the  key to select the Low power (1 watt: “**L**” icon appears).

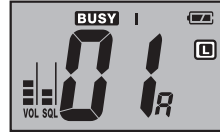

**Note:** Transmitting on Low power prolongs battery life. Low power should be selected whenever possible.

4. If using Low power is not effective, select High power (5 watts: “**H**” icon is not shown) by pressing the  key.
5. When receiving a signal, wait until communications stops before transmitting.

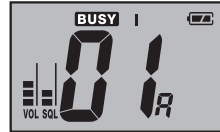

### NOTE

The transceiver cannot transmit and receive simultaneously.

6. Press the **PTT** (Push-To-Talk) switch to transmit. During transmission, the “**TX**” indicator will appear on the display.
7. Position your mouth about 1.2 to 2.5 cm away from the mic hole on the top right above the display. Speak slowly and clearly into the microphone.
8. When the transmission is finished, release the **PTT** switch.

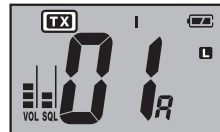

### 6.3.1 TRANSMIT TIME - OUT TIMER (TOT)



While the **PTT** switch is held down, transmission time is limited to 5 minutes. This prevents prolonged (unintentional) transmissions. About 10 seconds before automatic transmitter shutdown, a warning beep will sound from the speaker. The transceiver automatically switches to the receiving mode, even if the **PTT** switch is held down. Before transmitting again, the **PTT** switch must first be released, then wait 10 seconds and then pressed again. This Time-Out-Timer (TOT) prevents a continuous transmission that would result from an accidentally stuck **PTT** switch.

### WATER ENABLED LIGHT

When the **HX300E** comes in contact with water a red light will blink to assist retrieving it in low light conditions. The light will automatically turn off in about 15 seconds when it is removed from water.

The **HX300E** has a menu selection to enable, disable and select different blinking light times. Refer to Menu Mode Item “**FL (WATER ENABLED LIGHT)**” on page 32 for details.



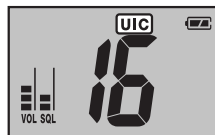

## 6.4 USA, CANADIAN, AND INTERNATIONAL CHANNELS

1. To change from US to International or Canadian Marine Channels, hold down the  key and press the  key. The band will change from USA, to International, and to Canadian with each press.
2. “U” appears on the LCD for the USA band, “I” appears for the International band, and “C” appears for the Canadian band
3. Refer to the marine channel charts in section “10. VHF MARINE CHANNEL ASSIGNMENTS” for allocated channels.



## 6.5 KEYPAD LOCKING

In order to prevent accidental channel change, the HX300E's keypad may be locked.

Hold down the  key to lock the keypad (except the **PTT**, , and  keys) so that they are not accidentally changed. The “” icon will appear on the channel number of the display, to indicate that the functions are locked.

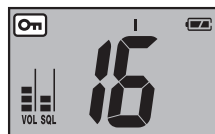







Hold down the  key until the “” icon disappears to unlock the radio.

## 6.6 PRESET CHANNELS (0 ~ 9): INSTANT ACCESS



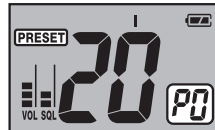

Ten user assigned channels can be programmed for instant access. Pressing the  key activates the user assigned channel bank (Preset Channel Bank).

### 6.6.1 PROGRAMMING

1. Select the desired channel to be assigned into the Preset Channel Bank using the  or  key.
2. Press and hold the  key until the “**PRESET**” icon blinks at the left of the channel number on the display.
3. Press the  or  key to select the desired Preset Channel (“P0” ~ “P9”).
4. Press the  key to program the current channel into the Preset Channel Bank.
5. Repeat steps 1 through 4 to program the other channel into Preset Channels, if desired.







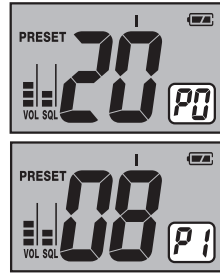

## 6.6.2 OPERATION

1. Press the  key to recall the Preset Channel. The “**PRESET**” icon and Preset Channel Number will appear on the display.
2. Press the  or  key to select the desired Preset Channel (“P0” ~ “P9”).
3. Press the  key again to return to the last selected channel. The “**PRESET**” icon will disappear from the display.



## 6.6.3 Deleting a Preset Channel



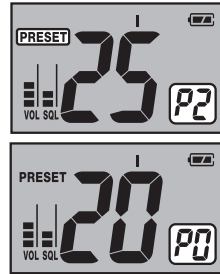



1. Press the  key to recall the Preset Channel.
2. Press the  or  key to select the Preset Channel to be deleted.
3. Press and hold the  key until the “**PRESET**” icon is blinking.
4. Press and hold the  key until “**PRESET**” icon indication is removed from the display.
5. Repeat steps 2 through 4 to delete the desired channels from Preset Channels “P0” ~ “P9”.
6. To finish the deleting the Preset Channel, press the  key again to return to the last selected normal channel.



## 6.7 SCANNING

The **HX300E** allows the user to select the scan type from “Memory Scan” or “Priority Scan”. “Memory Scan” scans the channels that were programmed into Scan Memory and also channels stored in the Preset Channel (“P0” ~ “P9”). “Priority Scan” is similar to the “Memory Scan” scan, however it scans the priority channel (channel 16) and dual watches to channels programmed in memory scan and preset channel memory. When an incoming signal is detected on one of the channels during scan, the radio will pause on that channel, allowing you to listen to the incoming transmission.

### 6.7.1 PROGRAMMING SCAN MEMORY

1. Turn the transceiver off by press and holding the  key.
2. Hold down the  key, and then turn on the transceiver while still holding down the  key. “**SET**” icon will appear on top right of the display.
3. Press the  or  key to select desired channel to be scanned, then press the  key. The “**M**” icon appears on the display, which indicates the channel has

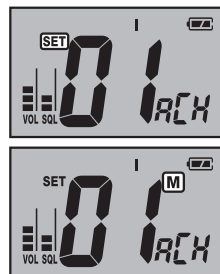



been selected to the scan channel.

4. Repeat step 3 for all desired channels to be programmed into scan memory.
5. To DELETE a channel from the scan memory, select the channel by pressing the or key, then press the key. The “M” icon disappears from the display.
6. When you have completed programming scan memory, turn the transceiver off and on by press and holding the key.

### 6.7.2 SELECTING SCAN TYPE

1. Turn the transceiver off by press and holding the key.
2. Hold down the key, and then turn on the transceiver while still holding down the key.
3. “SET” icon will appear on the display, indicating the Menu (“Set”) Mode has been activated.
4. Press the key until “SC” is shown in the bottom right of the display.
5. Press the or key to select “PS (Priority Scan)” or “MS (Memory Scan)”. The factory default is “PS (Priority Scan)”.

**Priority Scan:** Scans the Scan Memory Channel, Preset Channel, and the Priority Channel (Channel 16).

**Memory Scan:** Scans the Scan Memory and channels programmed into the Preset Channel memory.

6. After completing your selection, turn the transceiver off and on by press and holding the key.

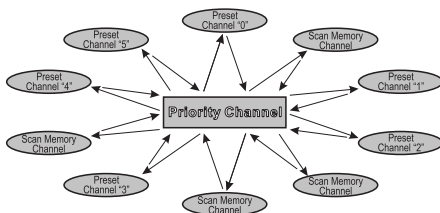

**PRIORITY SCAN**

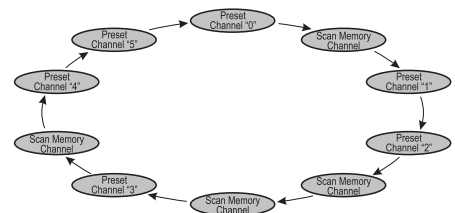





**MEMORY SCAN**

### 6.7.3 OPERATION



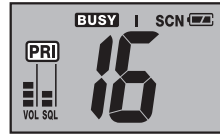
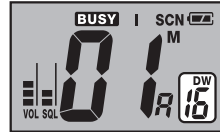
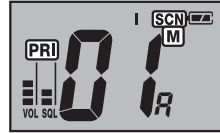

The operation of the “Priority Scan” or “Memory Scan” is determined via the section “6.8.2 SELECTING THE SCAN TYPE”

#### 6.7.3.1 Priority Scan

1. Press the  key two times until the “SQL” indicator blinks, to activate the squelch adjusting mode, then press the  /  key until the background noise disappears.
2. Press the  key to start scanning, a “SCN” icon and blinking “PRI” and “M” icons will appear on the display during scanning.
3. When the **HX300E** receives a transmission on a working channel, it will stop on the working channel and “Dual Watch” (described in next chapter) to the priority channel until the incoming signal disappears, then start scanning again.
4. When the **HX300E** receives a signal on the Priority channel it will stay on this channel until the incoming signal disappears, then start Priority scanning again.
5. To stop the scanning, press the  key.





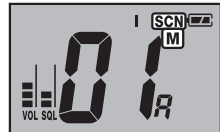

#### 6.7.3.2 Memory Scan

1. Press the  key several times until the “SQL” indicator blinks, to activate the squelch adjusting mode, then press the  /  key until the background noise disappears.
2. Press the  key to start scanning, a “SCN” icon and blinking “M” icon will appear on the display during scanning.
3. When the **HX300E** receives a transmission, it will stop on the channel until the incoming signal disappears, then start scanning again.
4. To stop the scanning, press the  key.



## 6.8 DUAL WATCH

The Dual Watch feature allows the radio watch the Priority Channel (Channel 16) and one other channel.



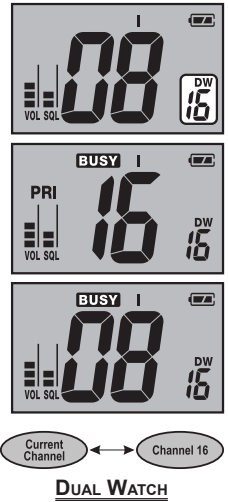

1. Select the desired channel using the  or  key.
2. Press and hold the  key for two seconds to activate the Dual Watch feature. A “DW” icon will appear on the display when the Dual Watch feature is activated.
3. When a transmission is received on the “Priority Channel”, the radio receives the “Priority Channel” until the incoming signal disappears.
4. When the **HX300E** receives a transmission on the working channel, the radio will dual watch between the working channel and Priority Channel (Channel 16).
5. The Dual Watch feature will resume when the incoming signal disappears at the end of the transmission.
6. To stop the Dual Watch feature and return to normal operation, press and hold the  key for two seconds again.



## 6.9 TRI-WATCH

You may change the Dual Watch feature to Tri-Watch via the Menu ("Set") Mode. Refer to Menu Mode Item "**dt (DUAL WATCH MODE)**" on page 32 for details.

The Tri-Watch scans Channel 16, 9, and one other channel. When enabled, a "**TW**" icon will appear on the display when the Dual Watch feature is activated.

1. Press the  /  key to select the channel to scan along with Channel 9 and 16.
2. Press and hold the  key for two seconds to activate the TRI-Watch feature. "**TW**" icon will appear on the display when the Tri-Watch feature is activated.
3. When a transmission is received on the channel 16, **HX300E** will stay on the channel 16 until the incoming signal disappears.
4. When a transmission is received on the channel 9, the **HX300E** will Dual watch between the channel 16 and channel 9.
5. When the **HX300E** receives a transmission on the working channel, the **HX300E** will Tri-watch between the working channel, channel 16, and channel 9.
6. To stop the Tri-watch feature and return to normal operation, press the  key.

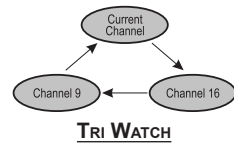
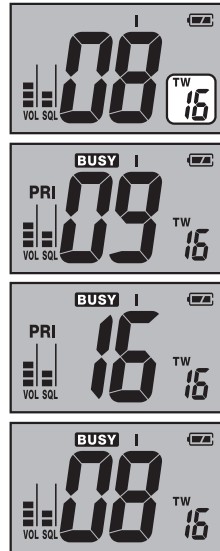













## 7. ATIS SETUP

The **HX300E** supports the ATIS (Automatic Transmitter Identification System) used in Inland waterways in Europe. When enabled ATIS mode transmits a unique ATIS code each time the **PTT** switch is released at the end of a transmission.

Users should check with their local marine regulatory authority in their country for assistance in obtaining an ATIS code.





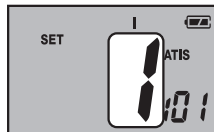
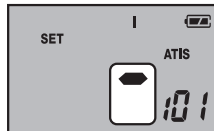
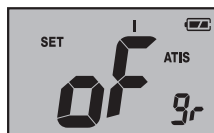





### 7.1 ATIS CODE PROGRAMMING

1. Turn the transceiver off by press and holding the  key.
2. Hold down the  and  key, and then turn on the transceiver while still holding down the  and  key.
3. Press the  key briefly to enable programming of the ATIS code.
4. Press the  key to select the first number of your ATIS, then press the  key to step to the next number.
5. Repeat step 4 to set your ATIS (ten digits).
6. If a mistake was made entering, repeatedly press the  key until the wrong number is selected, then press the  key to correct entry.
7. When finished programming the number, press and hold the  key, then set your ATIS number again.
8. Turn the transceiver off by press and holding the  key to store the ATIS number in memory.



## 7.2 ATIS CH GROUP

The **HX300E** has the capability to turn on and off the ATIS feature for each channel group.



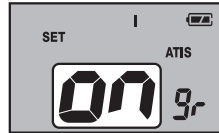
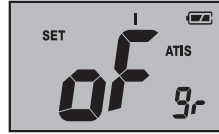
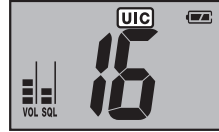





1. Hold down the  key and press the  key. The channel group will change from USA, to International, and to Canadian with each press.
2. “U” appears on the LCD for the USA, “I” appears for the International, and “C” appears for the Canadian.
3. Turn the transceiver off by press and holding the  key.
4. Hold down the  and  key, and then turn on the transceiver while still holding down the  and  key.
5. Press the  /  key to select “on”.
6. Turn the transceiver off by press and holding the  key to save the new setting.
7. If you want to set the ATIS feature to another channel group, repeat above steps.



## 8. MENU (“SET”) MODE

The **HX300E**'s Menu Mode allows a number of the **HX300E** operating parameters to be custom-configured.

The Menu Mode is easy to activate and set, using the following procedure:

1. Turn the transceiver off by press and holding the  key.
2. Hold down the  key, and then turn on the transceiver while still holding down the  key.
3. After “**SET**” icon appears on the display let go of both keys.
4. The  key when pressed scrolls through each menu item:
  - LP - Lamp mode,
  - bP - key beep,
  - SC - Scan Mode,
  - dt - Dual watch or Tri-Watch mode,
  - FL - Water Enabled Strobe Menu,
5. Press the  or  key will change the selection of the selected menu item.
6. Press the  key to save the menu selection.
7. After completing your adjustment, turn the transceiver off and on by press and holding the  key.



### LP (LAMP MODE)

**Function:** Selects the Lamp illumination method for the LCD/Keypad.

**Available Values:** on / ky / of

**Default:** kEY

on: Illuminates the LCD/Keypad continuously.

ky: Illuminates the LCD/Keypad for 5 seconds when any key is pressed.

oF: Turns off the backlight for the LCD and keys.



### bP (BEEP)

**Function:** Enable/Disable the Keypad beeper.

**Available Values:** HI / Lo / of

**Default:** HI



### **SC (SCAN TYPE)**

**Function:** Selects the Scan mode.

**Available Values:** PS (Priority Scan) / MS (Memory Scan)

**Default:** PS (Priority Scan)

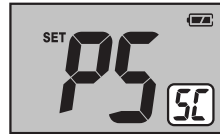

### **dt (DUAL WATCH MODE)**

**Function:** Selects dual or tri-watch as desired.

**Available Values:** du (Dual Watch) / tr (Tri Watch)

**Default:** d (Dual Watch)

tr (Tri Watch): The **HX300E** watches the activity of Channel 16, Channel 9, and the current channel.

du (Dual Watch): The **HX300E** watches the activity of the current channel and the Channel 16.

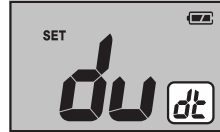

### **FL (WATER ENABLED LIGHT)**

**Function:** Enables the water enabled light when the **HX300E** comes in contact with water with the radio on or off. The light will turn on with the radio off or turned on.

**Available Values:** F1 / F2 / F3 / F4 / SO (SOS) / OF (OFF)

**Default:** F1

F1: Blinks slowly.

F2: Blinks fast.

F3: Blinks Medium.

F4: Blinks Rapidly.

SO: Blinks "S.O.S" Morse Code (••• --- •••).

OF: Disables the Water Enabled Light.





## 9. MAINTENANCE

### 9.1 GENERAL

The inherent quality of the solid-state components in STANDARD HORIZON radios will provide many years of continuous use. Take the following precautions to prevent damage to the radio.









- To prevent corrosion of electrical contacts and keep the water resistance, keep the battery cover latched and the charge cover closed while boating.
- Never press the **PTT** switch unless an antenna or suitable dummy load is connected to the antenna receptacle.
- Use only STANDARD HORIZON-approved accessories and replacement parts.

### 9.2 REPLACEMENT PARTS

Commonly requested parts, and their part numbers are listed below.

- **CAT460** Antenna: AY139X001
- **PA-54C/U** USB Wall Charger: Q9500201
- Charger Cable: T9101606
- Battery Cover: RA1377600
- **CLIP-22** Belt Clip: CP9672002
- Hand Strap: S6000418

### 9.3 TROUBLESHOOTING CHART

SYMPTOM	PROBABLE CASE	REMEDY
The  key does not start the scan.	No channel memorized.	Enter desired channels into the transceiver's Scan memory. Refer to section 6.7.1 "PROGRAMMING SCAN MEMORY".
	Squelch is not adjusted.	Press the  key several times until the "SQL" indicator blinks, then press the  key until the "BUSY" icon disappears. Further adjustment of the squelch level may eliminate incoming signal.
Cannot select between USA, INTL, Canadian bands.	Proper operation not followed.	Hold down the  key and press the  key.
Speaker audio is not heard when the  key is press and hold.	Low battery.	Charge battery. Refer to section 4.2.3 "BATTERY CHARGING".
	Audio volume is too low.	Press the  key several times until the "VOL" indicator blinks, then press the  key several times.
Some keys does not operate.	Key lock is on.	Hold down the  key for 2 seconds to turn the Key Lock off.
"CHG" indicator on the LCD does not appear while charging.	Detective battery <b>FNB-122LI</b> .	Contact your Standard Horizon dealer.

## 10. VHF MARINE CHANNEL ASSIGNMENTS

Tables on the following columns list the VHF Marine Channel assignments for USA. and International use. Below are listed some data about the charts.

1. VTS. Where indicated, these channels are part of the U.S. Coast Guard's Vessel Traffic System.
2. Alpha channel numbers, that is, channel numbers followed by the letter A (such as Channel 07A) are **simplex** channels on the USA. or Canadian channel assignments whose counterparts in the International assignments are **duplex** channels. International channels do not use "alpha" numbers. If you call the Coast Guard on Channel 16, they will sometimes ask you to "**go to channel 22 Alpha.**" This is a channel assigned to USA, and Canadian Coast Guards for handling distress and other calls. If your radio is set for **International** operation you will go to Channel 22 instead of 22A, and will not be able to communicate with the Coast Guard. To use Channel 22A, your radio must be set for **USA** or **Canada** operation, usually by a U/I/C (USA/International/Canada) control or combination of controls. Channel 22 (without an "A") is an **International** duplex channel for port operations. Some radios indicate an "A" adjacent to the alpha channels on the display; on others "alpha" is not indicated but the proper channel is selected based on the U/I/C setting.
3. Bridge-to-Bridge channels (for example, Channel 13) are for use by bridge operators on inter-coastal waterways and rivers. It is also used by marine vessels in the vicinity of these bridges for navigation and for communicating with the bridge operators. Note that a limit of 1 Watt is specified for these channels.
4. The **S/D** column on the chart indicates either S (simplex) or D (duplex). **Simplex** means transmitting and receiving on the same frequency. Only one party at a time can talk, unlike a telephone. Be sure to say "**over**" and release your microphone push-to-talk switch at the end of each transmission. **Duplex** operation involves the use of one frequency for transmitting and a separate frequency for receiving. On channels specified as duplex on the charts, correct mode of operation is established automatically by your radio when you select a channel; you cannot change the mode. And you still must release the push-to-talk switch after each transmission in order to listen to the radio.
5. Channels normally used by recreational boaters are those that include the term "non-commercial" in the **Channel Use** column of the chart. Some of these are shared with other users and some are used only in certain geographic regions.
6. Marine vessels equipped with VHF radios are required to monitor Channel 16.

VHF MARINE CHANNEL CHART							
CH	U	C	I	S/D	TX	RX	CHANNEL USE
01		X	X	D	156.050	160.650	Public Correspondence (Marine Operator)
01A	X			S	156.050		Port Operation and Commercial. VTS in selected areas
02		X	X	D	156.100	160.700	Public Correspondence (Marine Operator)
03		X	X	D	156.150	160.750	Public Correspondence (Marine Operator)
<b>03A</b>	<b>X</b>			<b>S</b>	<b>156.150</b>		<b>U.S. Government Only, Coast Guard</b>
04			X	D	156.200	160.800	Public Correspondence (Marine Operator), Port operation, ship movement
04A		X		S	156.200		Pacific coast: Coast Guard, East Coast: Commercial fishing
05			X	D	156.250	160.850	Public Correspondence (Marine Operator), Port operation, ship movement
05A	X	X		S	156.250		Port operation. VTS in Seattle
06	X	X	X	S	156.300		Inter-ship Safety
07			X	D	156.350	160.950	Public Correspondence (Marine Operator), Port operation, ship movement
07A	X	X		S	156.350		Commercial
08	X	X	X	S	156.400		Commercial (Inter-ship only)
09	X	X	X	S	156.450		Boater Calling channel, Commercial & Non-commercial (Recreational)
10	X	X	X	S	156.500		Commercial
11	X	X	X	S	156.550		Commercial. VTS in selected areas
12	X	X	X	S	156.600		Port operation. VTS in selected areas
13	X	X	X	S	156.650		Inter-ship Navigation Safety (Bridge-to-bridge)
14	X	X	X	S	156.700		Port operation. VTS in selected areas
15	X			S	---	156.750	Environmental (Receive only)
15		X	X	S	156.750		Commercial, non-commercial, ship movement (1 W)
16	X	X	X	S	156.800		International Distress, Safety and Calling
17	X	X	X	S	156.850		State Controlled (1 W)
18			X	D	156.900	161.500	Port operation, ship movement
18A	X	X		S	156.900		Commercial
19			X	D	156.950	161.550	Port operation, ship movement
19A	X			S	156.950		US: Commercial
19A		X		S	156.950		Coast Guard
20	X	X	X	D	157.000	161.600	Canadian Coast Guard Only, International: port operations and shipment
20A	X			S	157.000		Port operation
21			X	D	157.050	161.650	Port operation, ship movement
<b>21A</b>	<b>X</b>	<b>X</b>		<b>S</b>	<b>157.050</b>		<b>U.S. Government Only, Canadian Coast Guard</b>
22			X	D	157.100	161.700	Port operation, ship movement
22A	X	X		S	157.100		US and Canadian Coast Guard Liaison and aritime Safety Information Broadcasts announced on channel 16
23		X	X	D	157.150	161.750	Public Correspondence (Marine Operator)
<b>23A</b>	<b>X</b>			<b>S</b>	<b>157.150</b>		<b>U.S. Government Only</b>
24	X	X	X	D	157.200	161.800	Public Correspondence (Marine Operator)
25	X	X	X	D	157.250	161.850	Public Correspondence (Marine Operator)
26	X	X	X	D	157.300	161.900	Public Correspondence (Marine Operator)
27	X	X	X	D	157.350	161.950	Public Correspondence (Marine Operator)
28	X	X	X	D	157.400	162.000	Public Correspondence (Marine Operator)

## VHF MARINE CHANNEL CHART

CH	U	C	I	S/D	TX	RX	CHANNEL USE
60		X	X	D	156.025	160.625	Public Correspondence (Marine Operator)
61			X	D	156.075	160.675	Public Correspondence (Marine Operator), Port operation, ship movement
<b>61A</b>	<b>X</b>	<b>X</b>		<b>S</b>	<b>156.075</b>		<b>Public Coast: Coast Guard; East Coast: commercial fishing only</b>
62			X	D	156.125	160.725	Public Correspondence (Marine Operator), Port operation, ship movement
62A		X		S	156.125		Public Coast: Coast Guard; East Coast: commercial fishing onl
63			X	D	156.175	160.775	Public Correspondence (Marine Operator), Port operation, ship movement
63A	X	X		S	156.175		Port Operation and Commercial. VTS in selected areas
64		X	X	D	156.225	160.825	Public Correspondence (Marine Operator), Port operation, ship movement
<b>64A</b>	<b>X</b>	<b>X</b>		<b>S</b>	<b>156.225</b>		<b>Public Correspondence (Marine Operator), Port operation, ship movement</b>
65			X	D	156.275	160.875	Public Correspondence (Marine Operator), Port operation, ship movement
65A	X	X		S	156.275		Port Operations
66			X	D	156.325	160.925	Public Correspondence (Marine Operator), Port operation, ship movement
66A	X	X		S	156.325		Port Operations
67	X	X	X	S	156.375		US: Commercial. Used for Bridge-to-bridge communi-cations in lower Mississippi River. Inter-ship only, Canada: Commercial fishing, S&R
68	X	X	X	S	156.425		Non-commercial (Recreational)
69	X	X	X	S	156.475		US: Non-commercial (Recreational), Canada: Commercial fishing only, International: Inter-ship, Port operations and Ship movement
70	X	X	X	S	156.525		Digital selective calling (voice communications not allowed)
71	X	X	X	S	156.575		US, Canada: Non-commercial (Recreational), International: Port operations and Ship movement
72	X	X	X	S	156.625		Non-commercial (Inter-ship only)
73	X	X	X	S	156.675		US: Port Operations, Canada: Commercial fishing only, International: Inter-ship, Port operations and Ship movement
74	X	X	X	S	156.725		US: Port Operations, Canada: Commercial fishing only, International: Inter-ship, Port operations and Ship movement
75	X	X	X	S	156.775		Port Operations (Inter-ship only) (1W)
76	X	X	X	S	156.825		Port Operations (Inter-ship only) (1W)
77	X	X		S	156.875		Port Operations (Inter-ship only) (1W)
77			X	S	156.875		Port Operations (Inter-ship only)
78			X	D	156.925	161.525	Public Correspondence (Marine Operator), Port operation, ship-movement
78A	X	X		S	156.925		Non-commercial (Recreational)
79			X	D	156.975	161.575	Port operation and Ship movement
79A	X	X		S	156.975		Commercial

VHF MARINE CHANNEL CHART							
CH	U	C	I	S/D	TX	RX	CHANNEL USE
80			X	D	157.025	161.625	Port operation, ship movement
80A	X	X		S	157.025		Commercial
81			X	D	157.075	161.675	Port operation, ship movement
<b>81A</b>	<b>X</b>			<b>S</b>	<b>157.075</b>		<b>U.S. Government Only - Environmental protection operations</b>
81A		X		S	157.075		Canadian Coast Guard Only
82			X	D	157.125	161.725	Public Correspondence (Marine Operator), Port operation, ship movement
<b>82A</b>	<b>X</b>	<b>X</b>		<b>S</b>	<b>157.125</b>		<b>U.S. Government Only, Canadian Coast Guard Only</b>
83		X		D	157.175	161.775	Canadian Coast Guard Only
83			X	D	157.175	161.775	Public Correspondence (Marine Operator)
<b>83A</b>	<b>X</b>	<b>X</b>		<b>S</b>	<b>157.175</b>		<b>U.S. Government Only, Canadian Coast Guard Only</b>
84	X	X	X	D	157.225	161.825	Public Correspondence (Marine Operator)
85	X	X	X	D	157.275	161.875	Public Correspondence (Marine Operator)
86	X	X	X	D	157.325	161.925	Public Correspondence (Marine Operator)
87		X	X	S	157.375		Port operation, ship movement
87A	X			S	157.375		Public Correspondence (Marine Operator)
88		X	X	S	157.425		Port operation, ship movement
88A	X			S	157.425		Commercial, Inter-ship Only
M1			X	S	157.850		U.K. version Only
M2			X	S	161.425		U.K. version Only

**NOTE:** Simplex channels, 03A, 21A, 23A, 61A, 64A, 81A, 82A and 83A CANNOT be lawfully used by the general public in U.S.A. waters.

## 11. SPECIFICATIONS

Performance specifications are nominal, unless otherwise indicated, and are subject to change without notice.

### 11.1 GENERAL

<b>Frequency Ranges:</b>	TX: 156.025 MHz - 157.425 MHz RX: 156.050 MHz - 163.275 MHz
<b>Channel Spacing:</b>	25 kHz
<b>Frequency Stability:</b>	±5 ppm (–20 °C to +60 °C)
<b>Emission Type:</b>	16K0G3E
<b>Antenna Impedance:</b>	50 Ω
<b>Operating Voltage:</b>	3.7 V DC, Negative Ground
<b>Current Consumption:</b>	330 mA (Receive, Typical at AF MAX.) 20 mA (Standby) 2.3 A / 0.9 A (TX: 5 W / 1 W)
<b>Operating Temperature:</b>	–20 °C to +60 °C
<b>Case Size (W x H x D):</b>	59 x 128 x 33 mm (w/o knob & antenna)
<b>Weight (Approx.):</b>	240 g (with FNB-122LI, Belt Clip, & Antenna)

### 11.2 TRANSMITTER

<b>RF Power Output:</b>	5 W / 1 W (@3.7 V)
<b>Modulation Type:</b>	Variable Reactance
<b>Maximum Deviation:</b>	±5 kHz
<b>Spurious Emission:</b>	Less than 0.25 µW
<b>Microphone Impedance:</b>	2 kΩ

### 11.3 RECEIVER

<b>Circuit Type:</b>	Double-Conversion Superheterodyne
<b>Intermediate Frequencies:</b>	1st: 21.7 MHz, 2nd: 450 kHz
<b>Adjacent Channel Selectivity:</b>	70 dB
<b>Intermodulation:</b>	68 dB
<b>Hum &amp; Noise Ratio:</b>	40 dB
<b>Sensitivity:</b>	0.7 µV for 20 dB SINAD
<b>Selectivity:</b>	25 kHz (–70 dB)
<b>AF Output (Internal SP):</b>	600 mW @8 Ω for 10 % THD (@3.7 V)

*Measured in accordance with EN 301 178-2, EN 300 698-3, EN 301 843-2, and EN 60950-1.*

— Attention in case of use —

This transceiver works on frequencies which are not generally permitted. For frequency allocation, apply for a licence at your local spectrum management authority. For actual usage contact your dealer or sales shop in order to get your transceiver adjusted to the allocated frequency range.

List of the practicable area						
AUT	BEL	BGR	CYP	CZE	DEU	DNK
ESP	EST	FIN	FRA	GBR	GRC	HUN
IRL	ITA	LTU	LUX	LVA	MLT	NLD
POL	PRT	ROM	SVK	SVN	SWE	CHE
ISL	LIE	NOR	-	-	-	-

### Disposal of your Electronic and Electric Equipment

Products with the symbol (crossed-out wheeled bin) cannot be disposed as household waste.

Electronic and Electric Equipment should be recycled at a facility capable of handling these items and their waste byproducts.

In EU countries, please contact your local equipment supplier representative or service center for information about the waste collection system in your country.



## ***STANDARD HORIZON***

*Nothing takes to water like Standard Horizon*

### **YAESU MUSEN CO., LTD.**

Tennozu Parkside Building  
2-5-8 Higashi-Shinagawa, Shinagawa-ku, Tokyo 140-0002 Japan

### **YAESU USA**

6125 Phyllis Drive, Cypress, CA 90630, U.S.A.

### **YAESU UK LTD.**

Unit 12, Sun Valley Business Park, Winnall Close  
Winchester, Hampshire, SO23 0LB, U.K.

### **YAESU HK LTD.**

Unit 1306-1308, 13F., Millennium City 2, 378 Kwun Tong Road,  
Kwun Tong, Kowloon, Hong Kong

Copyright 2012

YAESU MUSEN CO., LTD.

All rights reserved.

No portion of this manual  
may be reproduced  
without the permission of  
YAESU MUSEN CO., LTD.

Printed in China



EM049N200