

ONWA[®]

MARINE ELECTRONICS



MODEL

KCOMBO-7

7-inch GPS Chart Plotter with built-in Fish Finder



K-CHART

Free detailed sea map



Support C-Map MAX



Compatible with Navionics+



Built-in Fish Finder



DUAL DISPLAY

Split Ratio is adjustable

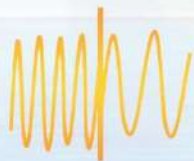

MULTIPLE DISPLAY (FREQUENCY)



Multiple Display Modes



Auto Range & Gain



Time Variable Gain



SD Card System Update



Display AIS Info

IP66
Ingress Protection

NMEA0183
NMEA Interface

➤ DIFFERENT DISPLAY MODES

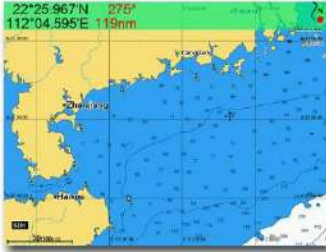

Plotter

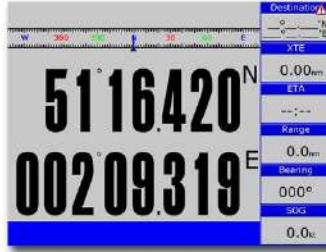

Navigation Data

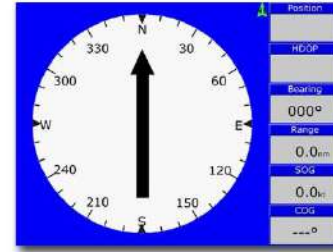

Compass

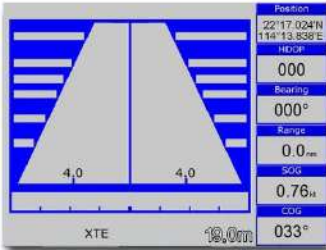

Highway

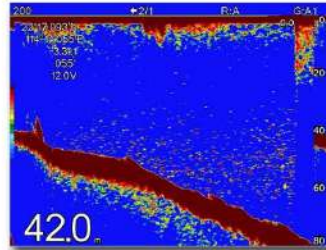

Sounder

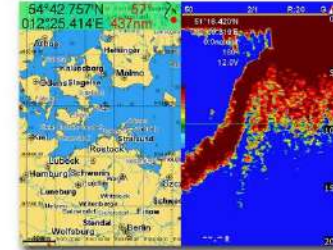

Plotter + Sounder



AIS

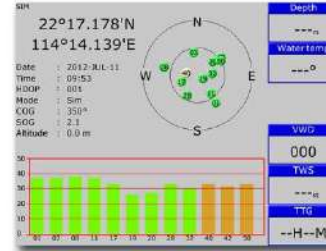

Satellite

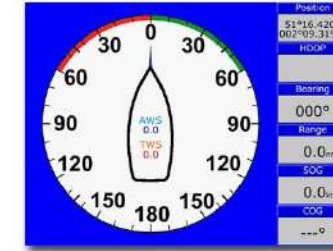

Wind

➤ GPS CHART PLOTTER

Compatible with the following mapping systems:

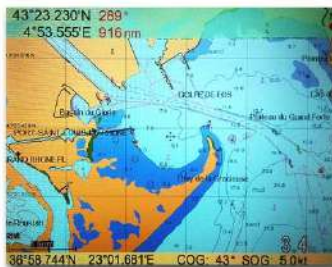

K-Chart Mapping System

ONWA Chart Plotters are compatible with K-Chart Mapping and displays worldwide Electronic Charts that users can use for FREE.

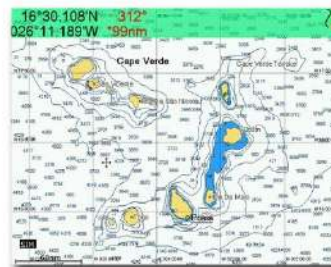

C-Map Max

ONWA Chart Plotters are also compatible with C-Map Max showing Nautical Charts



Navionics+

ONWA Chart Plotters when used with Navionics+ charts shows Nautical Charts and Sonar Charts. Advance options also include: Highlight Shallow Area, Adjust Contour Density and Shallow Fishing Range

Standard Accessory



GPS Patch Antenna
with 4m cable (SMA connector)
Ingress Protection IP66

Optional Accessory



KA-07
External GPS Antenna
with 10m cable
(Specify when ordering)

► BUILT-IN HD FISH FINDER TECHNOLOGY

*Transducer required

- Applies the most advanced Digital Fish Finder Technology
- Dual Frequency: 50 and 200kHz (alternately transmitted)
- Automatic Range and Gain adjustment depending on usage (Cruising or Fishing)

- > Excellent Sea-bed Discrimination and easily identify fishes and school of fish
- > Exact depth to where the school of fish is shown for ease of fishing

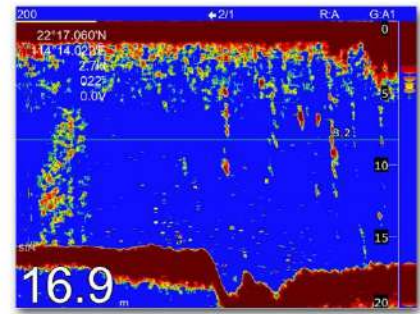

► DISPLAY MODES

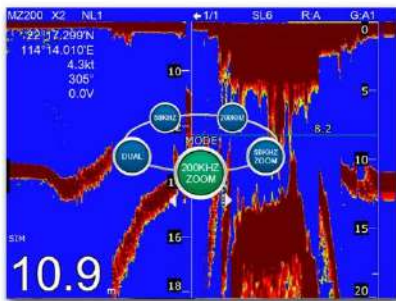

DISPLAY MODES

- > Selection of Display Modes depending on your need
- 50 KHz, 200KHz, Dual, 50KHz/Zoom and 200KHz/Zoom**

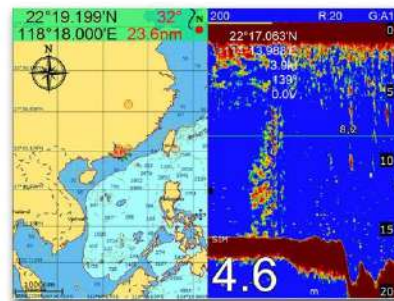

Split Screen with GPS Chart Plotter

- > Split Ratio can be adjusted as to which side is bigger for ease of usage
- > Beneficial for users to mark new fishing grounds

► FEATURES

16 Colors according to intensity

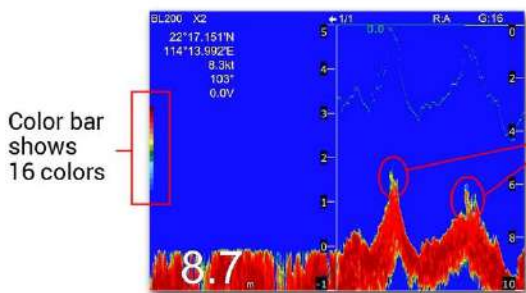

Color bar shows 16 colors

Can distinguish different strength of echoes by colors

Saves the position of a History Echo in Waypoint Memory

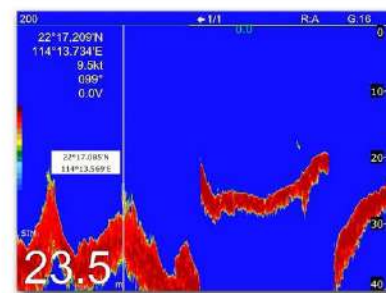

► FISH, BOTTOM, AND TEMPERATURE ALARMS

*Temperature sensor required for Temperature Alarm

- Fish Alarm:** Alarms when fish is seen at set range
- Bottom Alarm:** Alarms when the set bottom range is reached

- Temperature Alarm:** Used to warn the user when temperature reaches set temperature range

OPTIONAL ACCESSORIES

(not included in the standard set)



KTD-520_TM
Transom Mount
Transducer 600W



Bronze Transducer
Thru-hull Transducer
600W



Plastic Transducer
Thru-hull Transducer
600W



KTS-10K_TM
Transom Mount
Temperature
Probe



KTS-10K_TH
Thru-Hull
Temperature
Probe

PLOTTER CHARACTERISTICS

Waypoints/icons	12000 user waypoints with name, symbol 3 system waypoints: MOB, Start, Cursor 10 proximity waypoints
Routes	30 routes waypoint up to 170 points each, plus MOB and Track Navigation or GOTO Track modes
Tracks	8,000 points automatic track log;; 10 saved tracks (up to 8000 track points each) lets you retrace your path in both directions
Alarms	XTE, Anchor drag, arrival, speed, voltage, proximity waypoint, Timer and AIS (CPA and TCPA) alarm
Drawing	1000 Drawing Marks; 2000 Drawing Lines (40 points each); 1000 Drawing Place Name; 8 Colors for Drawing
Palette	Normal Daylight exposed to sunlight Night in dark environment NOAA paperchart colors Built-in Worldwide Tide data
Tides	Lat/Lon
Position format	Worldwide
Basemap	Compatible with K-Chart 2.0, K-Chart 3.0, C-Map Max and Navionics+
External Map	Internal backup of user settings or external SD-card
User data storage	5secs to 60 mins or 0.01 to 10nm
Plot Interval	0.001 to 700nm
Plotting scales	On/off (Available for C-Map only)
Perspective View	Sunrise/Sunset Moonrise/Moonset
Celestial	

NMEA SENTENCE SUPPORTED

INPUT: (Auto scan Baudrate)
GGA, GLL, GSA, GSV, RMC, HDG, HDM, HDT
VTG, ZDA, MTW, VWR, VWT, MWD, VPW, VHW
TLL, TTM, VDO, VDM, GNS, MTA
RMA, DBT, DPT, MWV, BWC, XTE, ZDL, WPL, AAM,
APB, BOD, RMB, DSC, MDA, RPM, XDR

OUTPUT:
Baudrate : Selectable 4800, 9600, 19200, 38400
GGA, GLL, RMC, GSA, GSV, AAM, APA
APB, BOD, BWC, BWR, DBT, DPT, HDT
MTW, RMB, TLL, VTG, WPL, XTE, ZDA
ZTG, ZDL, MWD, VPW, VWR, VWT
Outputs for autopilot:
APA, APB, BOD, XTE

AIS INTERFACE

AIS Data: RS232 output VDO, VDM, GGA, GSA, GSV and VTG
AIS Input Baudrate: 38,400 from GPS Input Port

POWER SUPPLY

10.5 to 30VDC, current drain 1.5A at 12V

PHYSICAL

Size 155mm(H) X 243mm(W) X 84.6mm(D)
Weight 0.6kg
Display 7-inch Color TFT dayview LCD, 800x600 pixels
Waterproofing Display unit: IP66
Antenna unit: IP66
Temperature range Display unit: -15°C to +55°C
Antenna unit: -25°C to +70°C

OPTIONAL ACCESSORIES

GPS antenna KA-07
Transom Mount or Thru-Hull Transducer
KC-2W (N2K to NMEA0183 Bidirectional converter)



KA-07
GPS Antenna



KTD-520
Transom Mount



NMM40-50/200
Thru-Hull Mount Transducer
(Bronze)



KW-360
Ultrasonic Weather
Station/Anemometer



KA-GC9A
9-Axis Electronic Compass
with built-in High Accuracy
GPS Module

GPS RECEIVER CHARACTERISTICS

Receiver	50 parallel channel GNSS receiver continuously tracks and uses up to 50 satellites to compute and update your position
Acquisition time	Cold start: 29 seconds Hot start: 1 second
Update rate	1 second or 0.1 second selectable
Accuracy	Position: 3 meters(95%) without S/A Velocity: 0.1 meter/sec without S/A
SBAS	Supported
QZSS	Supported
Satellite System Dynamics	Choice of 4 GNSS : GPS, Beidou, GLONASS, Galileo
Datum	Altitude: 18,000 m
Antenna	Velocity: 515 m/s WGS 84 & User defined GPS Patch Antenna

GPS INTERFACE

GPS Data	RS232 input/output, NMEA 0183 V3.01 and V4.11
GPS Input Baudrate	Auto Scan (4800, 9600, 19200 and 38400)
GPS Output Baudrate	Selectable among 4800, 9600, 19200 and 38400

ECHO SOUNDER

Echo Color 16 colors (including background color) according to echo intensity. The background color is selectable from blue, light blue, white and black.

Basic Range *The basic ranges can be changed on the system menu

Range Shift Meters 5/10/20/40/80/150/200/300/600/1000
Feet 15/30/60/120/200/400/600/1000/2000/3000
Fathoms 3/5/10/20/40/80/100/150/300/600
Up to 1000 meters (3000 feet, 600 fathoms)

Zoom Range Times 2, 3, 4 and 6 ranges

Bottom Lock Expansion Range 5/10 meters, 10/20 feet, 2/5 fathoms

Auto Mode Automatic adjustment of range and gain

Display Mode High Frequency (200K), Low Frequency (50K), Dual (200K and 50K 1/2 display on each), Zoom (200K and 50K zoom) and A-scope Display

Zoom Display Marker Zoom, Bottom Zoom and Bottom-lock Expansion

Display Advance Speed Lines/TX: Freeze, 1/8, 1/4, 1/2, 1/1, 2/1, 4/1, 6/1, 8/1 and 10/1

TX Frequency 50 and 200kHz (alternately transmitted)

Power Output 600W

Display End Depth (m)	5	10	20	40	80	150	200	300	600	1000
Pulse Length 200K (µs)	120	220	320	520	920	1020	1020	1020	1020	1020
Pulse Length 50K (µs)	170	270	370	570	970	1070	1070	1070	1070	1070
TX Rate (pulse/min)	2000	1333	706	353	171	98	75	53	38	27
TX period (millisecond)	30	45	85	170	350	610	800	1120	1580	2200

Interference Rejecter Rejects unwanted signals by comparing last and present echoes in strength

Alarm Fish and Bottom alarms, Temperature alarm (sensor required)

EQUIPMENT LIST

Display unit
Quick manual
Mounting Bracket
GPS Patch Antenna with 4m cable (SMA connector)
Standard Accessories Pack

KW-360 Ultrasonic Weather Station
KA-GC9A (Heading Sensor)
Transom Mount or Thru-Hull Temperature Probe



NBM40-50/200
Thru-Hull Mount Transducer
(Plastic)



KC-2W
N2K (NMEA2000) and NMEA0183
Bidirectional Converter



KTS-10K_TM
Transom Mount
Temperature
Probe



KTS-10K_TH
Thru-Hull
Temperature
Probe

INTERCONNECTION DIAGRAM

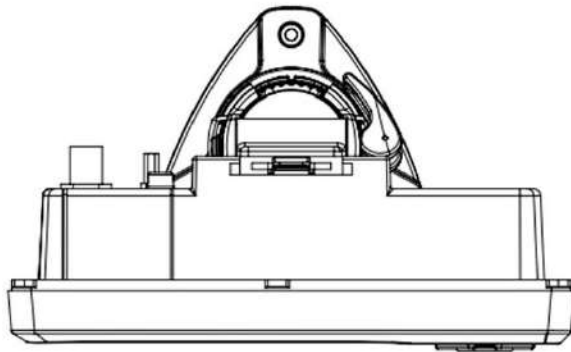
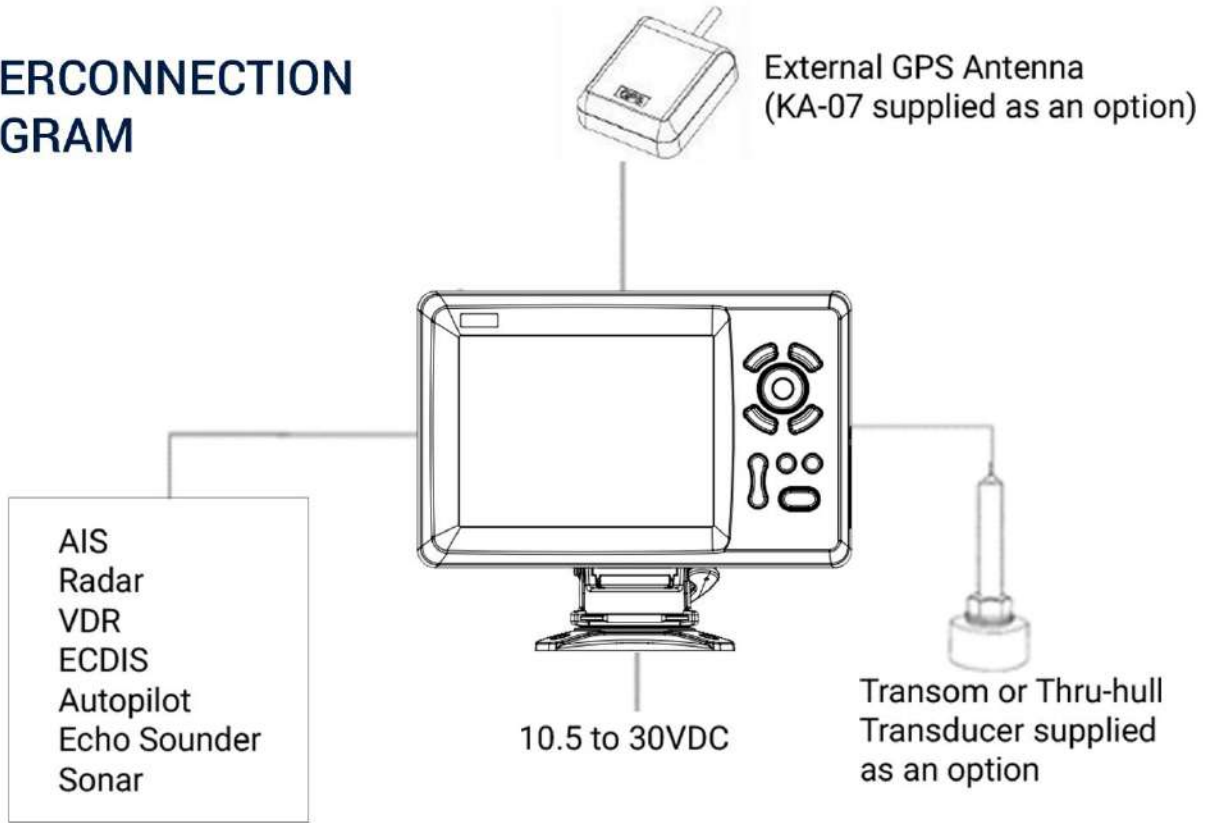

DIMENSIONS (DISPLAY UNIT)

